

## Thermo Scientific UltiMate 3000 RSLCnano System



**UHPLC<sup>+</sup>**  
focused

*Thermo Scientific LC products are UHPLC compatible by design, establishing the new standard in conventional LC. Integrating hardware, software, and separation chemistry, Thermo Scientific offers UHPLC to everyone—for all needs.*

*The Thermo Scientific UltiMate™ 3000 RSLCnano system provides ultrafast, ultrahigh-resolution separations using a powerful nano LC pump that can deliver up to 800 bar pressure. The thoughtfully engineered system design together with Thermo Scientific nanoViper™ fingertight fittings makes this system easy-to-use, allowing operators to set up advanced solutions in minutes.*

*Thermo Scientific Acclaim PepMap™ RSLC columns efficiently resolve the most challenging biological samples. This system is ideally suited for coupling to mass spectrometry, both with ESI and MALDI interfaces.*

### System Features

- Continuous direct flow
- Small gradient delay volume of only 25 nL
- Flow delivery from 20 nL/min up to 50 µL/min at a maximum pressure of 800 bar
- Unparalleled gradient precision
- Integrated ternary gradient pump, 10–2500 µL/min
- Up to two low-dispersion 2-position switching valves
- Nano, capillary, and micro LC applications
- Can perform multidimensional separations
- Easy coupling to ESI and MALDI MS
- UHPLC-compatible fingertight connections
- High-resolution columns
- Zero sample-loss injection
- High-precision sample injections down to 10 nL
- Sample fractionation and automated reinjection
- Sample cooling down to 4 °C
- UV detector for nano LC using a 3 nL flow cell
- Data collection rate of 200 Hz
- Automatic IQ/OQ/PQ through Thermo Scientific Dionex Chromeleon™ software



Part of Thermo Fisher Scientific

Now sold under the  
Thermo Scientific brand

**Thermo**  
SCIENTIFIC

## NCS-3500RS Module

The NCS-3500RS module integrates a continuous direct flow HPG nano pump, a ternary LPG micro pump, and a heated column compartment with up to two UHPLC-compatible switching valves. It is designed for maximum flexibility and ease-of-use, supporting any workflow in nano, capillary, and micro LC. Optimized system geometry and a revolutionary new Dionex nanoViper fingertight fitting assure optimum LC performance without concerns about connections.

## HPG Nano Pump

The continuous direct flow HPG nano pump delivers flow rates from 20 nL/min up to 50  $\mu$ L/min at standard or ultrahigh backpressures up to 800 bar. The pump is designed to deliver gradients at the lowest imaginable flow rates with the exceptionally high precision required for high confidence compound identification.

## HPG Nano Pump Features

- Column pressures up to 800 bar (11,600 psi) over the entire flow range from 20 nL/min up to 50  $\mu$ L/min
- Fast separations with a gradient delay volume as small as 25 nL
- Unparalleled small retention time variations ensured by precise gradient formation and high pressure mixing
- Easily exchangeable flow selector for maximum pump performance and system flexibility

## LPG Micro Pump Features

- Ternary gradient
- Flow rates from 10  $\mu$ L/min up to 2.5 mL/min
- Ideal for on-line sample loading and multidimensional LC workflows

## NCP-3200RS Module

The HPG nano pump is also available as a stand alone module, the NCP-3200-RS. The specifications are similar to the NCS-3500RS HPG pump. The pump can be used for direct sample analysis or, in combination with the NCS-3500RS module, for advanced applications such as tandem nano LC or 2D-LC.



Figure 1. The NCS-3500RS module supports ultrahigh backpressures up to 800 bar across nano, capillary, and micro LC flow rates. The integrated switching valve(s) together with nanoViper fittings facilitate configuration of any workflow.

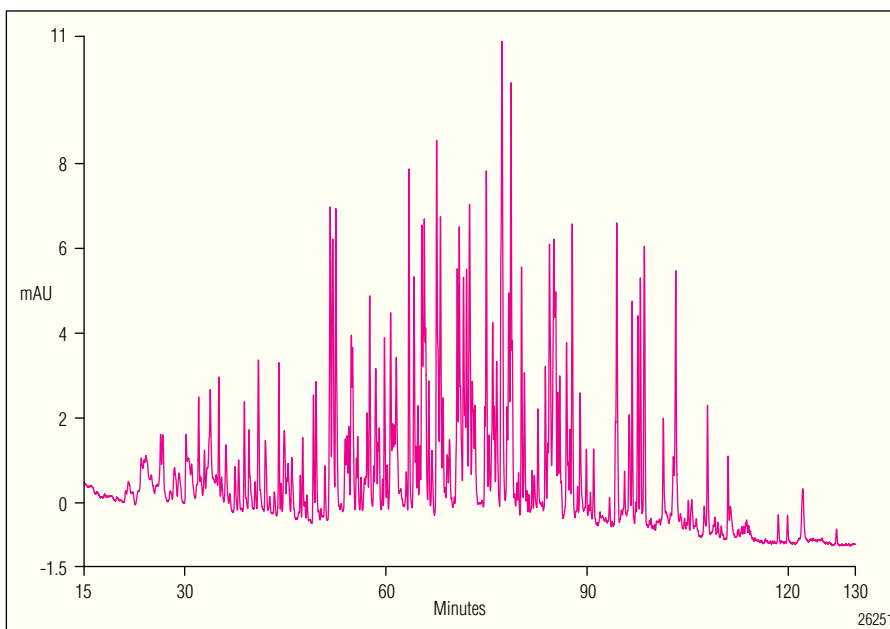

Figure 2. High-resolution separation of a complex tryptic digest sample using a 50 cm 75  $\mu$ m Acclaim PepMap column. The peak capacity for this separation was 450.

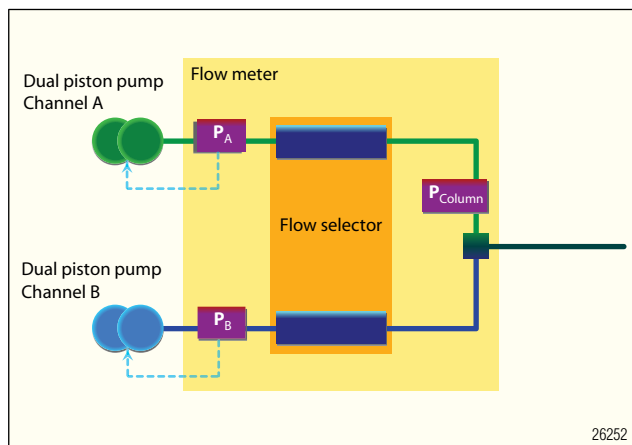

Figure 3. Schematic of the HPG nano pump. The dual piston design for each solvent channel, optimized fluidics, and smart algorithms enable stable flow rates from 20 nL/min up to 50  $\mu$ L/min, independent from backpressure changes caused by ultrafast gradients or a partially blocked capillary like an ESI spray needle.

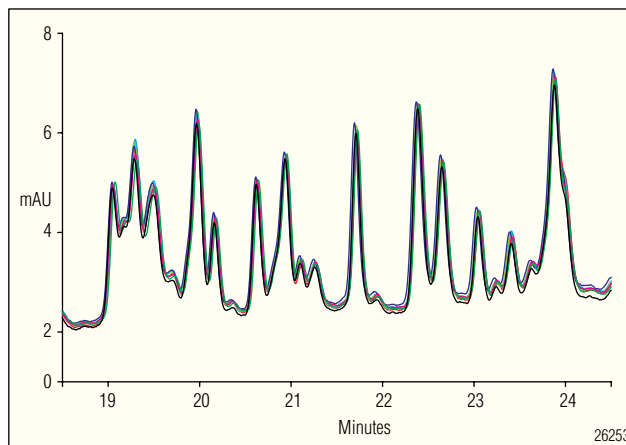

Figure 4. Unparallelled retention time precision in a nano LC preconcentration analysis of tryptic peptides. Zoom in of overlay of eight consecutive runs with retention time precision  $\leq 0.05\%$  RSD for all peptides.

## KEY PUMP SPECIFICATIONS

### Flow Rate Ranges:

HPG Nano Pump: 20 nL/min–50  $\mu$ L/min  
(using dedicated flow selectors)

Flow Selectors (recommended):

Nano: 50 nL/min–1000 nL/min

Capillary: 500 nL/min–10  $\mu$ L/min

Micro: 2.5  $\mu$ L/min–50  $\mu$ L/min

Custom flow selectors (e.g. for 20 nL/min) are available on request.

LPG Micro Pump: 10–2500  $\mu$ L/min (NCS-3500RS only)

### Pressure Range:

20–800 bar (300–11,600 psi), HPG Nano Pump

20–500 bar (300–7250 psi), LPG Micro Pump

### Number of Solvent Channels:

HPG Nano Pump: 2

LPG Micro Pump: 3

### Flow Calibration:

Semi-automated

### Proportioning Accuracy:

<1% of full scale

### Proportioning Precision:

Typically <0.2% SD

### Retention Time RSD in Gradient Mode at 300 nL/min:

<0.2% RSD or <0.1 min SD, whichever is greater

### Gradient Delay Volume:

<25 nL (pump) and

<350 nL (system in preconcentration configuration)

### Eluent Bottles:

2  $\times$  100 mL

3  $\times$  500 mL

### Solvent Degassing:

External (optional)

### Wetted Parts:

HPG Nano Pump: titanium, PEEK, UHMW-PE, PTFE, FEP, ruby, sapphire,  $\text{Al}_2\text{O}_3$ , fused silica

LPG Micro Pump: titanium, PEEK, UHMW-PE, PTFE, FEP, ruby, sapphire,  $\text{ZrO}_2$ ,  $\text{Al}_2\text{O}_3$ , Kalrez<sup>®</sup>

### Dimensions (h $\times$ w $\times$ d):

NCS-3500RS: 36  $\times$  42  $\times$  51 cm (14.1  $\times$  16.5  $\times$  20 in.)

NCP-3200RS: 21  $\times$  42  $\times$  51 cm (8.3  $\times$  16.5  $\times$  20 in.)

### Weight:

NCS-3500RS: 32 kg (70.6 lb)

NCP-3200RS: 17.5 kg (38.6 lb)

### Power Requirements:

100–120 V, 60 Hz

200–240 V, 50 Hz; max 300 VA

### PC Connection:

USB 2.0; USB hub with three integrated sockets

### I/O Interfaces:

Two digital inputs and two programmable outputs

### Additional Communication Port:

15-pin D-Sub port for connection of a solvent rack or degasser

### GLP Features:

System wellness monitoring, column tracking

### Safety Features:

Leak sensor, active rear-seal wash system, excess pressure monitoring

## Column Compartment

The column compartment has been designed to provide maximum operational flexibility and convenience. Two low-dispersion switching valves and a maximum temperature of 75 °C provide full flexibility for any column-switching experiment. The 10-port or 6-port switching valves can be pulled forward and taken out for easy access and column installation.

## Column Compartment Features

- Thermostatted column compartment from 10 °C above room temperature (RT) to 75 °C
- Up to two low-dispersion 2-position, 10-port or 6-port snap-in valves
- Column identification system for easy data storage



Figure 5. The snap-in switching valve and the proprietary fingertight nanoViper fittings provide the highest level of convenience and confidence for column installation.

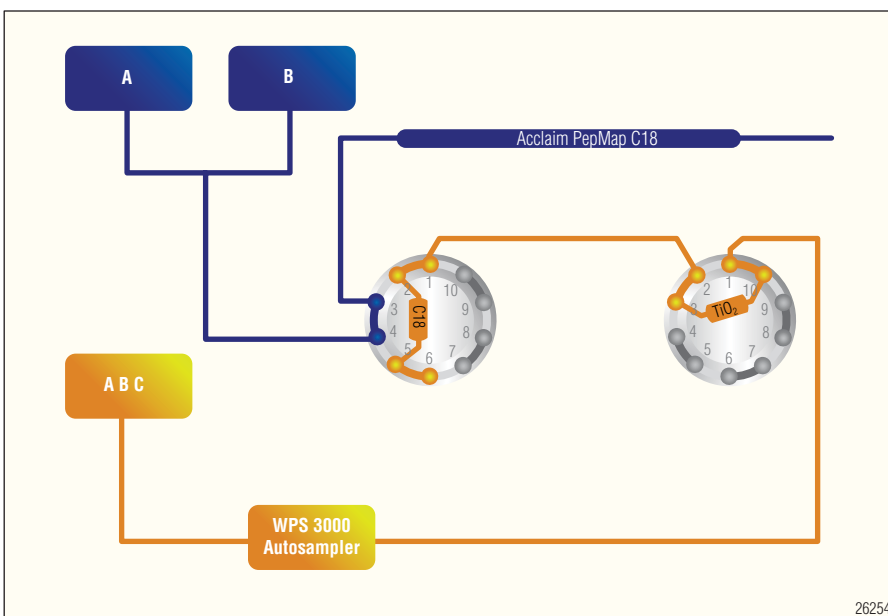

Figure 6. Advanced workflows such as phosphopeptide analysis are easily supported by the Dionex UltiMate 3000 RSLCnano system using the 2-position switching valves in the thermostatted column compartment.

## KEY COLUMN COMPARTMENT SPECIFICATIONS

### Temperature Range:

RT + 10 °C–75 °C

### Temperature Accuracy:

± 0.5 °C

### Temperature Stability:

± 0.1 °C (at 50 °C setpoint)

### Heat-Up Time:

From 35 °C to 65 °C in 15 min

### Switching Valves:

Up to two 10-port, 2-position low-dispersion valves

Port-to-port volume: 124 nL

Maximum pressure: 900 bar (13,050 psi)

### Column Capacity:

Up to 3 columns

Up to 100 cm length (75 µm i.d., coiled)

### Safety Features:

Humidity sensor, leak sensor

## WPS-3000TPL RS Autosampler

The WPS-3000TPL RS autosampler uses a 2.4 µL needle to allow injection of the smallest sample volumes with high precision and with no sample loss. The injection valve supports injections at ultrahigh pressures, both directly onto the column or onto a sample trapping column. The injection valve supports injections at ultrahigh pressures, both directly onto the column or onto a sample trapping column. The optional sample fractionation provides the highest application flexibility in multidimensional workflows. The sample compartment is entirely closed to ensure sample stability.

### Autosampler Features

- Microliter pick-up injections for zero sample loss
- Automated wash routines to prevent sample carryover
- Injection valve pressure rating of 900 bar
- User-defined programs for unlimited sample handling capabilities
- Sample thermostating from 4 °C to 45 °C, at least 22 °C below ambient, to help prevent sample degradation
- Dual-needle injection design, supporting injection from sealed sample carriers

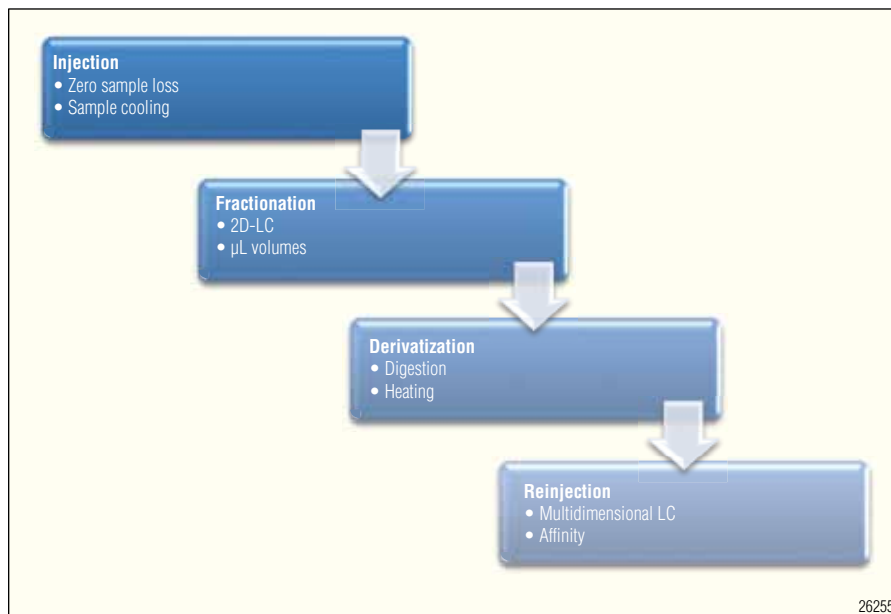

Figure 7. Automated sample handling and LC workflows facilitated by the micro fractionation option of the WPS-3000TPL RS autosampler.

- Large injection volume range, from 10 nL up to 125 µL
- Microfractionation option for highest application flexibility
- Three well plate sample capacity
- Flexible multiple-tray carrier supporting all common sample carriers

## KEY AUTOSAMPLER SPECIFICATIONS

### Injection Volume Range:

10 nL–125 µL (with installed options)

### Sample Formats:

96 (deep) well plate, 384 (deep) well plate, 24 deep well plate, sealed or open; 40 standard autosampler vials, 1.8 mL, sealed or open

### Sample Capacity:

3× well plate (128 × 86 mm)  
15× 10 mL vials for reagents, diluents, and transport liquids

### Injection Cycle Time:

30 s for a 1 µL full loop injection

### Injection Methods:

Full loop, partial loop, low-dispersion injection  
Microliter pick-up, user-defined injection programs

### Injection Technique:

Needle-in-needle with programmable needle wash

### Injection Valve Precision:

<0.4% RSD for 1 µL full loop injection

### Injection Linearity:

Corr. coeff. > 0.9995 from 100–500 nL injections

### Carryover:

<0.02% with needle wash (caffeine)

### Optional Sample Cooling

4 °C–45 °C, at least 22 °C below ambient

### Fraction Collection:

Microfraction collection option [up to 345 bar (5000 psi)]

### Wetted Parts:

PEEK, Stainless steel, PCTFE, fused silica

### Dimensions (h × w × d):

36 × 42 × 51 cm (16 × 16.5 × 20 in.)

### Weight:

22.7 kg (50 lb) including cooling

### Power Requirements:

85–260 V, 50/60 Hz, max. 320 W

### PC Connection:

USB; USB hub with three integrated sockets

### I/O Interfaces:

Four digital inputs and four programmable outputs

## VWD-3400RS UV Detector

The powerful UV detector with its uniquely designed flow cells allows detection of the smallest amounts of analytes. The use of UV detection provides an ideal tool to monitor low flow LC-MS systems and does not contribute to extracolumn dispersion typically seen when applying too-large flow cells.

### UV Detector Features

- High-sensitivity UV data using dedicated nano and capillary flow cells
- Nano LC flow cell with a volume of 3 nL
- High data collection rate up to 200 Hz
- Up to four wavelengths detected simultaneously.

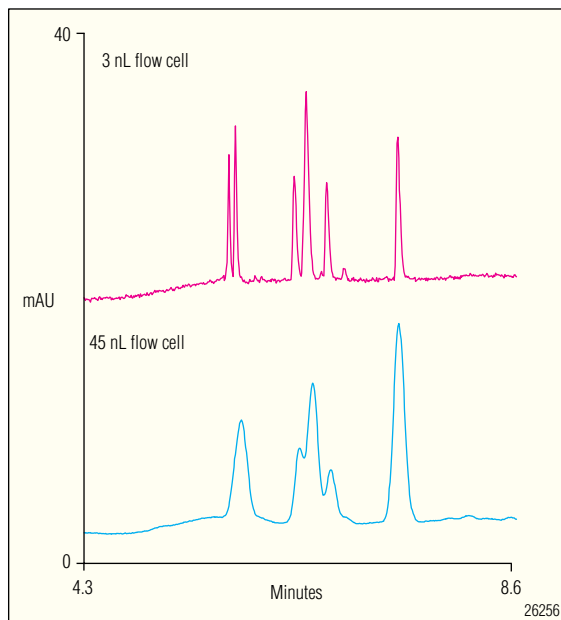

Figure 8. Effect of flow cell volume on resolution of peptides, separated on a 0.2 mm i.d. PS-DVB monolithic column at 2.5  $\mu\text{L}/\text{min}$ .



Figure 9. Dedicated UV flow cells for nano and capillary LC.

## KEY DETECTOR SPECIFICATIONS

### Data Collection Rate:

Up to 200 Hz (in single wavelength mode)

### Maximum Number of Channels:

4

### Drift:

4.0 mAU/h

### Wavelength Range:

190–900 nm

### Noise:

Typically <0.05 mAU at 254 nm

### Lamp:

Deuterium lamp, Tungsten lamp

### Flow Cell Volume:

3 nL for nano LC

45 nL for capillary LC

180 nL for micro LC

### Dimensions ( $h \times w \times d$ ):

16  $\times$  42  $\times$  51 cm (6.3  $\times$  16.5  $\times$  20 in.)

### Weight:

15 kg (33 lb)

### Power Requirements:

85–260 V, 50/60 Hz, max. 150 W

### PC Connection:

USB

### I/O Interfaces:

Four digital inputs and four digital outputs

Two analog inputs (optional DAC module)



## Acclaim PepMap RSLC Columns

The system is complemented by a new set of Acclaim PepMap RSLC 2  $\mu\text{m}$  columns, to provide high-efficiency separations with exceptionally high resolution.

### Column Features

- Highest resolution in peptide mapping
- nanoViper fittings for easy, tool-free installation
- High sample loadability
- Designed for TFA-free LC-MS, minimizing ion-suppression effects
- Ideally suited for coupling to ESI-MS and MALDI-MS
- Highest column-to-column reproducibility
- Easy-to-use, cutting-edge miniaturized HPLC

### Software

The UltiMate 3000 RSLCnano system is supported by Chromeleon chromatography data management system for convenient system control. DCMS<sup>Link</sup>™ software plug-ins provides single-point control for all major MS platforms.

### Chromeleon Software Features

- Intuitive panels for easy system control
- Easy to use diagnostics tests allow users to monitor system performance

### DCMS<sup>Link</sup> Features

Single-point LC-MS control for:

- Applied Biosystems' Analyst™
- Bruker Daltonic's HyStar™
- Thermo Fisher's Xcalibur™

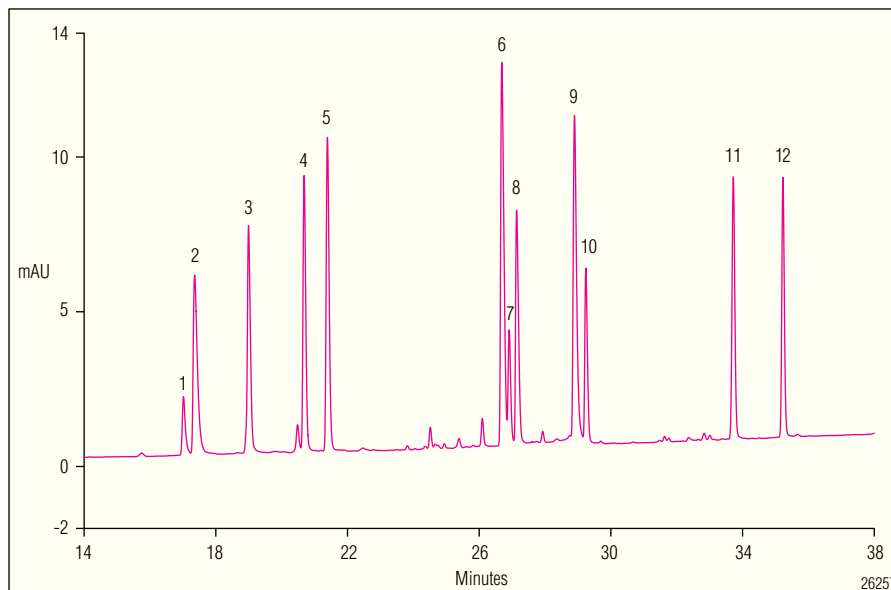

Figure 10. Separation of a cytochrome c digest on an Acclaim PepMap RSLC C18, 2  $\mu\text{m}$  nano column. The high resolution obtained by using a small particle size is immediately clear from the chromatogram.

Peak	PWHHs
3	5.8
4	5.5
5	5.8
11	5.5
12	5.0

Peak width at half height for tryptic peptides separated on an Acclaim PepMap RSLC column using a 1.25%  $\text{CH}_3\text{CN}/\text{min}$  gradient at a flow rate of 300 nL/min.



Figure 11. DCMS<sup>Link</sup> seamlessly integrates the power of Chromeleon software into the MS software to implement single-point LC-MS control.

## ORDERING INFORMATION

To order, use the following part numbers and contact your local Thermo Scientific office or distributor nearest you. In the U.S., call (800) 346-6390. In other regions, refer to the phone numbers below.

Product Description	Part Number
NCS-3500RS Nano LC Pump with Column Compartment.....	5041.0010
NCS-3500RS Capillary LC Pump with Column Compartment .....	5041.0020
NCP-3200RS Nano/Capillary Pump.....	5041.0030
WPS-3000TPL RS Pulled-Loop Well Plate Sampler.....	5826.0020
WPS-3000TBPL Biocompatible Pulled-Loop Well Plate Sampler .....	5821.0020
VWD-3400RS Variable Wavelength Detector .....	5074.0010
SRD-3400 Solvent Rack with Four Degasser Channels .....	5035.9245
Low-Dispersion 2-Position 10-Port Valve for the NCS-3500RS.....	6041.0001
Low-Dispersion 2-Position 6-Port Valve for the NCS-3500RS.....	6041.0004
Low-Dispersion 2-Position 10-Port Valve for the NCS-3500RS, Biocompatible, PAEK .....	6041.0012
UV Flow Cell for Nano LC, 3 nL, for VWD-3400RS .....	6074.0270
UV Flow Cell for Capillary LC, 45 nL, for VWD-3400RS .....	6074.0280
UV Flow Cell for Micro LC, 1810 nL, for VWD-3400RS .....	6074.0290
Flow Meter for the NCS-3500RS or NCP-3200RS, Nano .....	6041.7901
Flow Meter for the NCS-3500RS or NCP-3200RS, Capillary .....	6041.7902
Flow Meter for the NCS-3500RS or NCP-3200RS, Micro .....	6041.7903
Flow Selector for NCS-3500RS or NCP-3200RS, Nano LC (50–1000 nL/min.....	6041.0002
Flow Selector for NCS-3500RS or NCP-3200RS, Capillary LC (0.5–10 µL/min .....	6041.0003
Flow Selector for NCS-3500RS or NCP-3200RS, Micro LC (5-50 µL/min.....	6041.0014
Mixer Kit 8 µL, for the NCS-3500RS or NCP-3200RS, Capillary .....	6041.7130

Analyst is a registered trademark of Applied Biosystems.

Hystar is a trademark of Bruker Daltonics.

Kalrez is a registered trademark of E. I. du Pont de Nemours.

All other trademarks are property of Thermo Fisher Scientific Inc. or its subsidiaries.

**Speed • Simplicity • Solutions**



**Dionex Products**

1228 Titan Way  
P.O. Box 3603  
Sunnyvale, CA  
94088-3603  
(408) 737-0700

**North America**

U.S./Canada (847) 295-7500

**South America**

Brazil (55) 11 3731 5140

**Europe**

Austria (43) 1 616 51 25 Benelux (31) 20 683 9768; (32) 3 353 4294  
Denmark (45) 36 36 90 90 France (33) 1 39 30 01 10 Germany (49) 6126 991 0  
Ireland (353) 1 644 0064 Italy (39) 02 51 62 1267 Sweden (46) 8 473 3380  
Switzerland (41) 62 205 9966 United Kingdom (44) 1276 691722

**Asia Pacific**

Australia (61) 2 9420 5233 China (852) 2428 3282 India (91) 22 2764 2735  
Japan (81) 6 6885 1213 Korea (82) 2 2653 2580 Singapore (65) 6289 1190  
Taiwan (886) 2 8751 6655

[www.thermoscientific.com/dionex](http://www.thermoscientific.com/dionex)



LPN 2343-05 PDF 8/11

©2011 Thermo Fisher Scientific, Inc.